

Seznam - nýty:

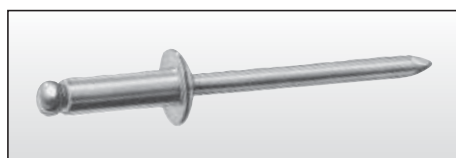

<i>Materiál</i>	<i>Typ</i>	<i>Hlava</i>	<i>Série</i>	<i>Strana</i>
Standardní trhací nýty				
hliník/ocel		plochá	1031	1
hliník/ocel		velká	1032	2
hliník/ocel		extra velká	1033	2
hliník/ocel		zapuštěná	1034	3
ocel/ocel		plochá	1041	5
ocel/ocel		zapuštěná	1044	6
nerez A2/nerez A2		plochá	1051	7
nerez A4/nerez A4		plochá	1541	8
nerez A2/nerez A2		velká	1052+1053	8
nerez A2/nerez A2		zapuštěná	1054	9
hliník/hliník		plochá	1021	4
hliník/nerez A2		plochá	1071	4
mří/ocel		plochá	1101	10
mří/bronz		plochá	1151	10
NiCu/ocel		plochá	0818	9

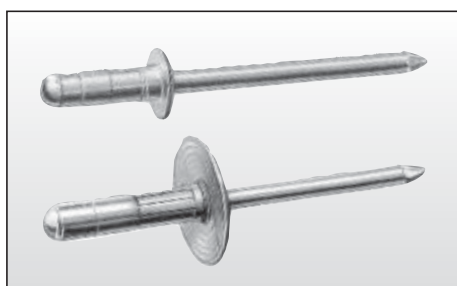

Širokorozsahové nýty				
hliník/ocel	AVEX	plochá	1691+1001	11
hliník/ocel	AVEX	velká	1002	13
hliník/ocel	AVEX	velká	1641+1003	14
hliník/ocel	AVEX	zapuštěná	1604+1004	14
hliník/nerez A4	AVEX	plochá	1663+1441	13
hliník/nerez A4	AVEX	velká	1643	14
ocel/ocel	AVEX	plochá	1624+1461	11
nerez A2/nerez A2		plochá	1451	15
hliník/ocel bílý	AVEX	plochá	1171	12
hliník/ocel černý	AVEX	plochá	1181	12

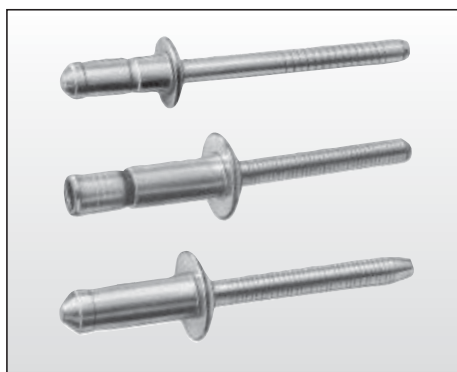

Pevnostní (strukturální nýty)				
ocel/ocel	AVIBULB	plochá	BN01	16
ocel/ocel	STAVEX	plochá	BS01	16
ocel/ocel	MASTERLOCK	plochá	1471+1561	17
ocel/ocel	MASTERLOCK	velká	1472	18
ocel/ocel	MASTERLOCK	zapuštěná	1474	18
ocel/ocel	MASTERLOCK	zapuštěná	1514	18
hliník/hliník	MASTERLOCK	zapuštěná	1511	17
nerez A4/nerez A4	AVINOX II.	plochá	BE61	17
ocel/ocel	HEMLOK	plochá	2221	18
hliník/hliník	HEMLOK	plochá	2241	19
ocel/ocel	MONOBOLT	plochá	2771	19
ocel/ocel	MONOBOLT	zapuštěná	2761	20
hliník/hliník	MONOBOLT	plochá	2774	19
hliník/hliník	MONOBOLT	zapuštěná	2764	19
nerez A2/nerez A2	MONOBOLT	plochá	2711	20
nerez A2/nerez A2	MONOBOLT	zapuštěná	2721	20

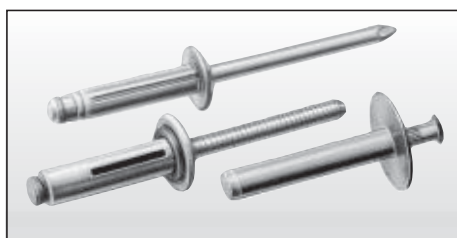

Nýty pro speciální aplikace				
hliník/hliník	BULBEX	plochá	BF01	21
hliník/nerez A2	HSN	velká	1803	21
ocel/ocel	T-LOK	plochá	BM01	22
hliník/ocel	T-LOK	plochá	1301	22
hliník/ocel		plochá	1601	23



Vodotěsné nýty

hliník/ocel		plochá	1201	24
hliník/ocel		velká	1202	24
hliník/ocel		zapuštěná	1204	25
ocel/ocel		plochá	1241	26
ocel/ocel		velká	1242	27
hliník/hliník		plochá	1211	25
hliník/nerez A2		plochá	1231	26
hliník/nerez A2		zapuštěná	1234	26
nerez A2/nerez A2		plochá	1261	28
nerez A2/nerez A2		velká	1262	28
měď/nerez A2		plochá	1281	28
měď/ocel		plochá	1251	27

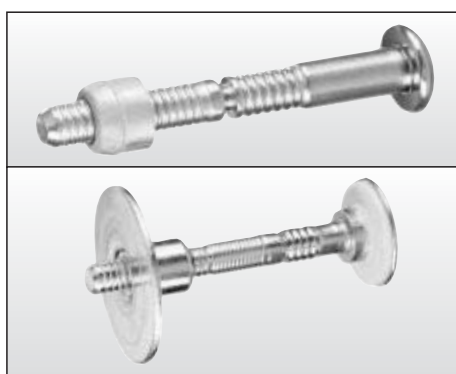

Kolíky se závěrným kroužkem

29

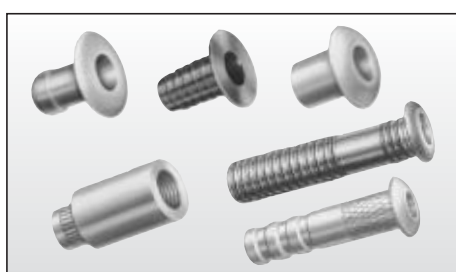

Magazínové nýty

30 - 31



Plastové krytky trhacích nýtů

23

Nářadí ruční, pneumatické, akumulátorové

32 - 36

